

DFS COMPONENT

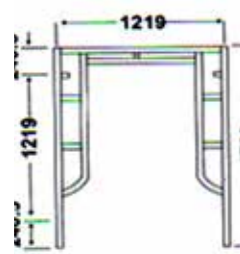

Main Frame DM101

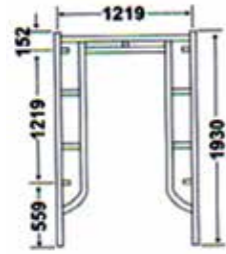

Main Frame DM101A

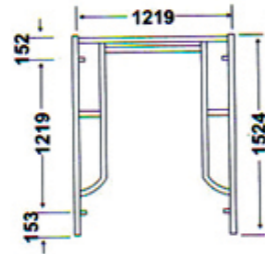

Open End Frame DM102

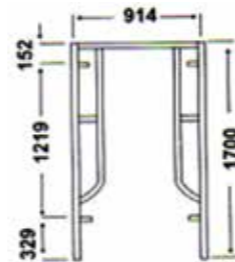

Open End Frame DM103

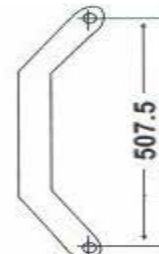

Arm Lock DM 801

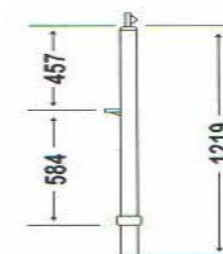

Guard Rail Post DM 901



Guard Rail DM 902

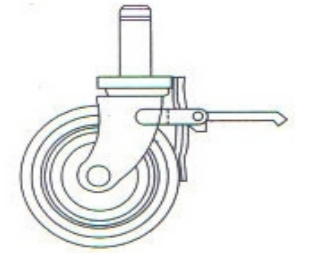

Caster Wheel DM 603

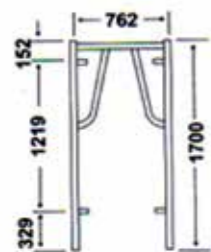

Light Frame DM104

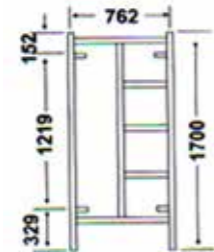

Light Frame DM106

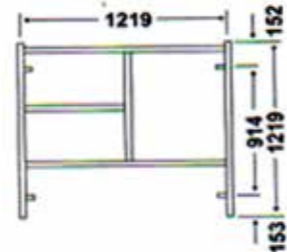

Ladder End Frame DM108

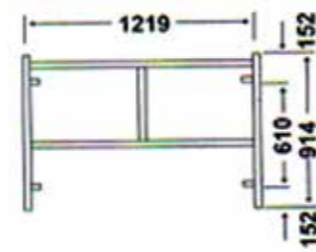

Ladder End Frame DM109



Wall Tie DM 501

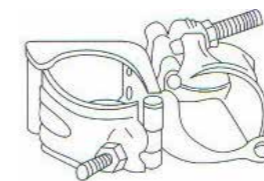

Swivel / Fixed Clamp DM 486

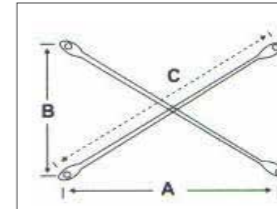

Cross Brace

Item	A	B	C
DM 301A	1829	1219	2198
DM 301B	1829	914	2054
DM 301C	1829	610	1928
DM 301D	1829	280	1850
DM 301E	1219	1219	1724
DM 301F	1219	610	1363

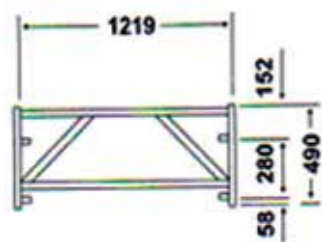

Ladder End Frame DM110

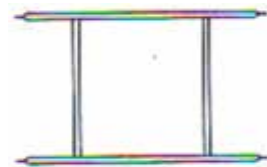

Walking Frame DM110

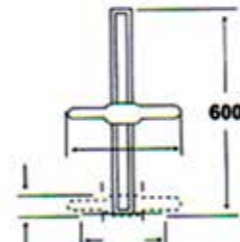

Jack Base DM 601B

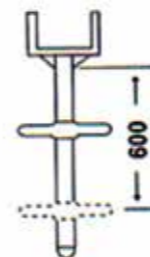

U - Head DM 602B



Steel Prop / Vertical Prop

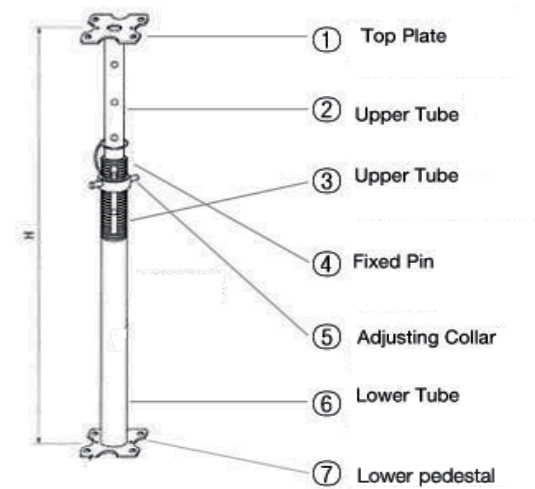

All Steel Construction - Reduces Fire Hazard.

A One-Man Operation System - Erected in less than a minute:

- i) Extend tube to required height.
- ii) Set pin through hole of inner tube.
- iii) Screw Collar-Adjust to close tolerances without wedging.

High Grade Steel-Stronger and Lighter. They can take more weight than timber props.

Model	Fully Extended / Max. length	Closed / Min. length
DC 70	3,500mm (11' - 5")	2,000mm (6' - 5.6") 2,000mm (6' - 5.6")
DC 90	3,900mm (12' - 8")	2,400mm (7' - 8.7") 2,400mm (7' - 8.7")

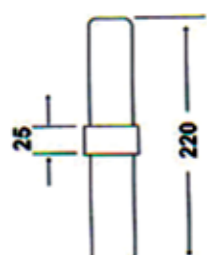

Joint Pin DM 701

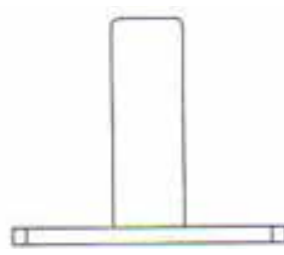

Base Plate DM 604

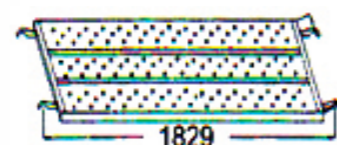

Walking Board DM 205

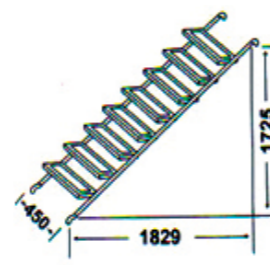

Stair DM 514